

Kod-Code	VM401
Profil-Profil	50 Boru Profil-Ø50 Pipe Profile
Ağırlık-Weight	1.01kg/m

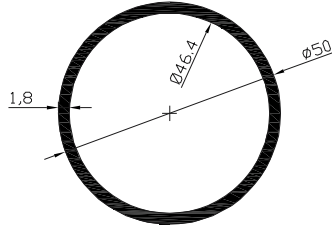

Kod-Code	VM402
Profil-Profil	50 Boru Profil-Ø50 Pipe Profile
Ağırlık-Weight	0.734kg/m

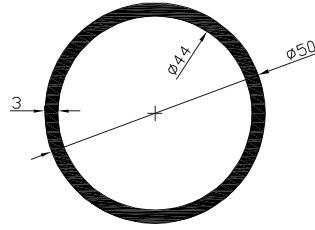

Kod-Code	VM403
Profil-Profil	50 Boru Profil-Ø50 Pipe Profile
Ağırlık-Weight	1.196kg/m

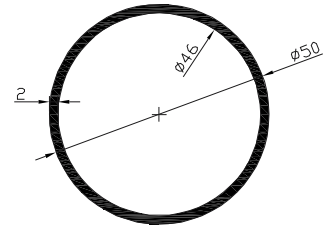

Kod-Code	VM404
Profil-Profil	50 Boru Profil-Ø50 Pipe Profile
Ağırlık-Weight	0.815kg/m

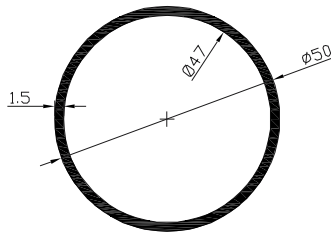

Kod-Code	VM405
Profil-Profil	50 Boru Profil-Ø50 Pipe Profile
Ağırlık-Weight	0.616kg/m

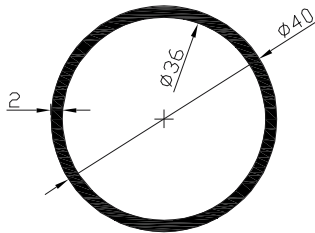

Kod-Code	VM406
Profil-Profil	40 Boru Profil-Ø40 Pipe Profile
Ağırlık-Weight	0.644kg/m

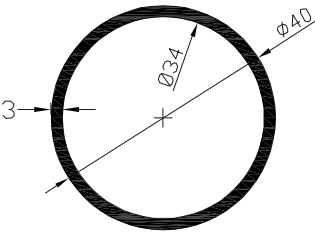

Kod-Code	VM407
Profil-Profil	40 Boru Profil-Ø40 Pipe Profile
Ağırlık-Weight	0.942kg/m

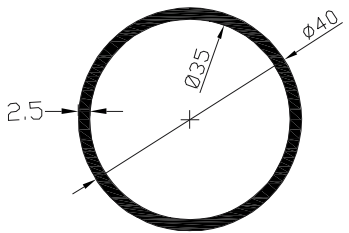

Kod-Code	VM408
Profil-Profil	40 Boru Profil-Ø40 Pipe Profile
Ağırlık-Weight	0.797kg/m

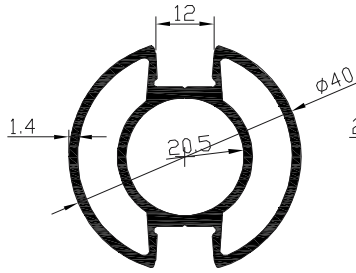

Kod-Code	VM409
Profil-Profil	40 Dikme -Ø40 Poppet
Ağırlık-Weight	0.802kg/m

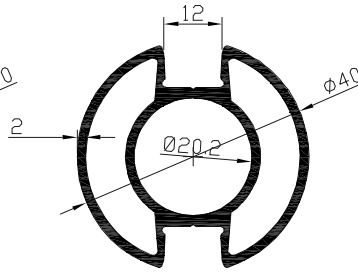

Kod-Code	VM410
Profil-Profil	40 Dikme -Ø40 Poppet
Ağırlık-Weight	1.24kg/m

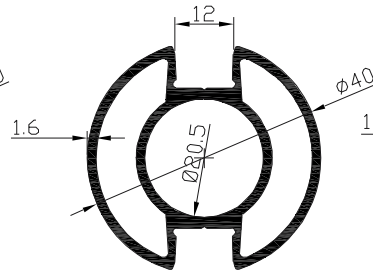

Kod-Code	VM411
Profil-Profil	40 Dikme -Ø40 Poppet
Ağırlık-Weight	0.948kg/m

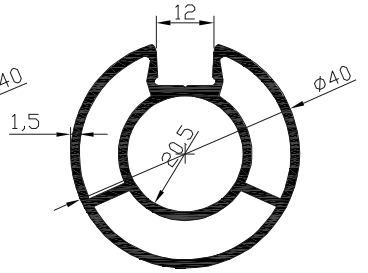

Kod-Code	VM412
Profil-Profil	40 Dikme -Ø40 Poppet
Ağırlık-Weight	0.872kg/m

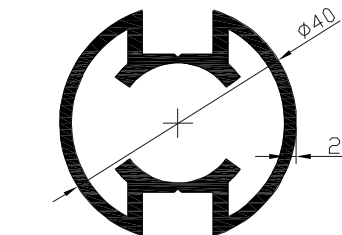

Kod-Code	VM413
Profil-Profil	40 Dikme -Ø40 Poppet
Ağırlık-Weight	0.942kg/m

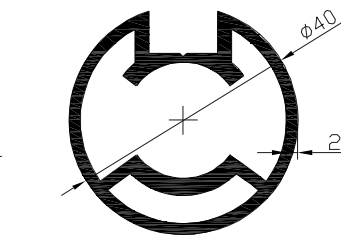

Kod-Code	VM414
Profil-Profil	40 Dikme -Ø40 Poppet
Ağırlık-Weight	0.99kg/m

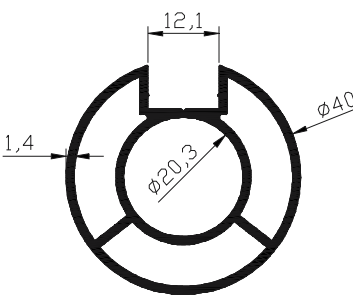

Kod-Code	VM415
Profil-Profil	40 Dikme -Ø40 Pipe Profile
Ağırlık-Weight	0.830kg/m

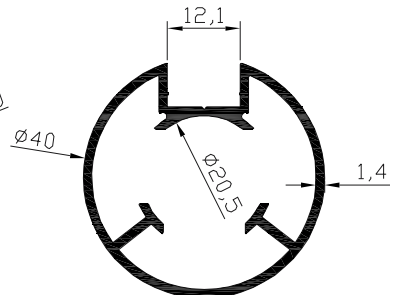

Kod-Code	VM416
Profil-Profil	40 Boru Profil-Ø40 Pipe Profile
Ağırlık-Weight	0.670kg/m

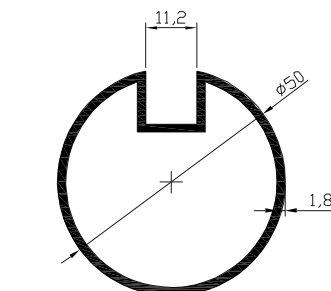

Kod-Code	VM417
Profil-Profil	50 Boru Profil-Ø50 Pipe Profile
Ağırlık-Weight	0.857kg/m

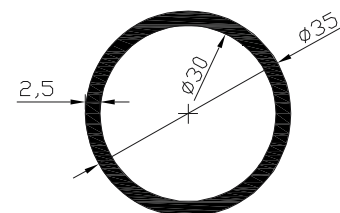

Kod-Code	VM418
Profil-Profil	35 Boru Profil-Ø35 Pipe Profile
Ağırlık-Weight	0.689kg/m

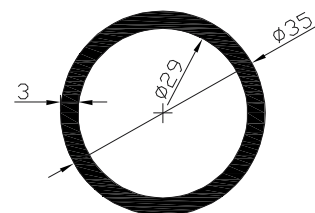

Kod-Code	VM419
Profil-Profil	35 Boru Profil-Ø35 Pipe Profile
Ağırlık-Weight	0.813kg/m

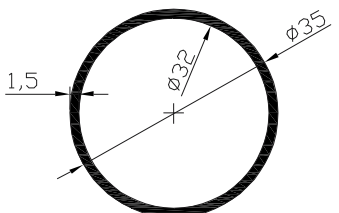

Kod-Code	VM420
Profil-Profil	35 Boru Profil-Ø35 Pipe Profile
Ağırlık-Weight	0.426kg/m

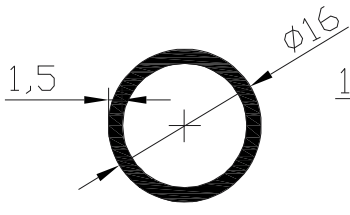

Kod-Code	VM421
Profil-Profil	16 Boru Profil-Ø16 Pipe Profile
Ağırlık-Weight	0.184kg/m

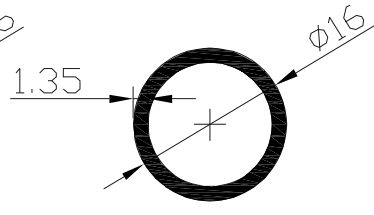

Kod-Code	VM422
Profil-Profil	16 Boru Profil-Ø16 Pipe Profile
Ağırlık-Weight	0.167kg/m

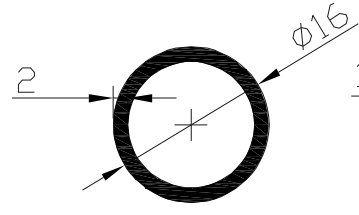

Kod-Code	VM423
Profil-Profil	16 Boru Profil-Ø16 Pipe Profile
Ağırlık-Weight	0.238kg/m

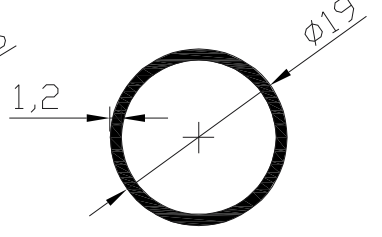

Kod-Code	VM424
Profil-Profil	19 Boru Profil-Ø19 Pipe Profile
Ağırlık-Weight	0.181kg/m

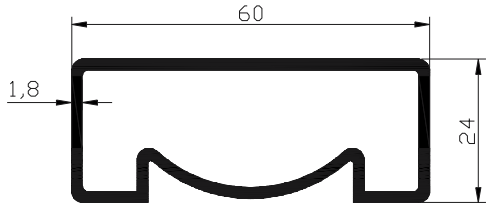

Kod-Code	VM428
Profil-Profil	60x24 Profil-60x24 Profile
Ağırlık-Weight	0.837kg/m

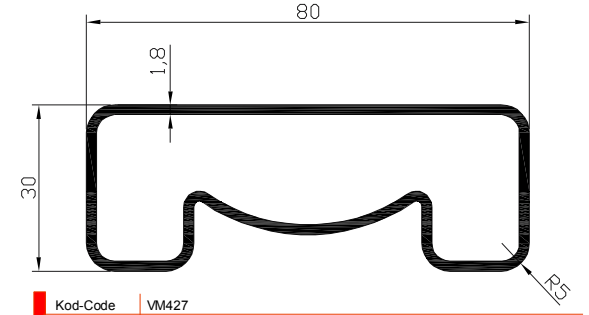

Kod-Code	VM427
Profil-Profil	80x30 Profil-80x30 Profile
Ağırlık-Weight	1.15kg/m

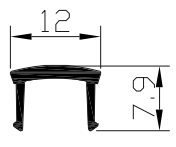

Kod-Code	VM425
Profil-Profil	Dikme Kapak-Poppet Cover
Ağırlık-Weight	0.08kg/m

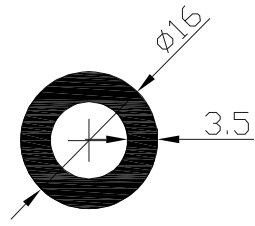

Kod-Code	VM426
Profil-Profil	16 Boru Profil-Ø16 Pipe Profile
Ağırlık-Weight	0.370kg/m

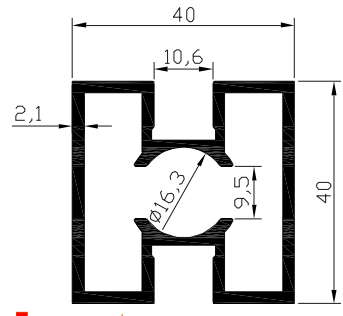

Kod-Code	VM429
Profil-Profil	40x40 Kare-40x40 Square
Ağırlık-Weight	1.147kg/m

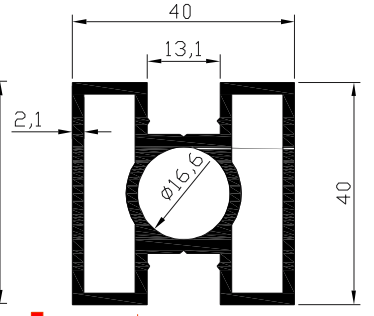

Kod-Code	VM430
Profil-Profil	40x40 Kare-40x40 Square
Ağırlık-Weight	1.314kg/m

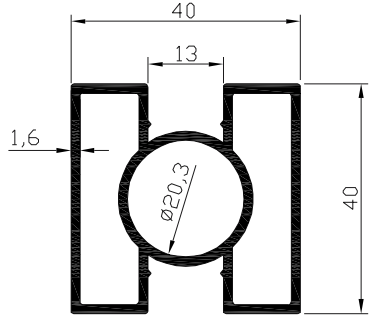

Kod-Code	VM431
Profil-Profil	40x40 Kare-40x40 Square
Ağırlık-Weight	1.058kg/m

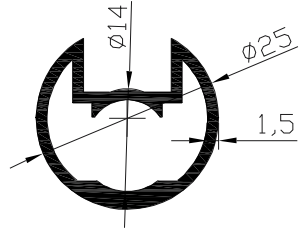

Kod-Code	VM432
Profil-Profil	25 Boru Profil-Ø25 Pipe Profile
Ağırlık-Weight	0.534kg/m

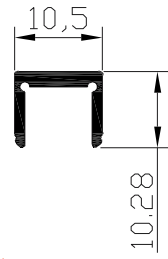

Kod-Code	VM433
Profil-Profil	Dikme Kapak-Poppet Cover
Ağırlık-Weight	0.095kg/m

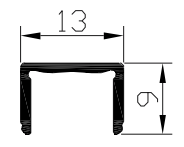

Kod-Code	VM434
Profil-Profil	Dikme Kapak-Poppet Cover
Ağırlık-Weight	0.09kg/m

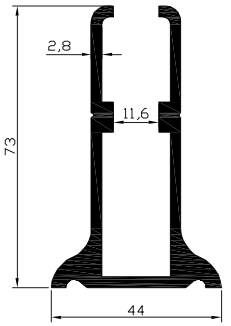

Kod-Code	VM435
Profil-Profil	Dikme Profil-Strut Profile
Ağırlık-Weight	1.667kg/m

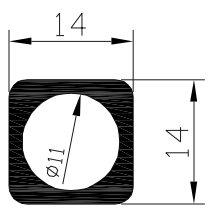

Kod-Code	VM436
Profil-Profil	14x14 Kare-14x14 Square
Ağırlık-Weight	0.251kg/m

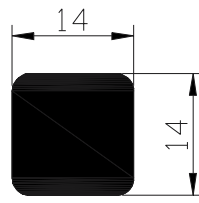

Kod-Code	VM437
Profil-Profil	14x14 Dolu Prf.-14x14 Solid Prf.
Ağırlık-Weight	0.534kg/m

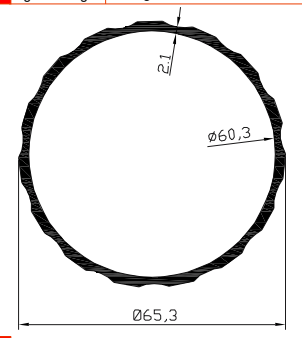

Kod-Code	VM438
Profil-Profil	Nervürlü Boru-Ribbed Pipe
Ağırlık-Weight	1.084kg/m